



Cranio-maxillofacial Repair and Reconstruction System



Catalogue | *CMF*



Cranio-maxillofacial Repair and Reconstruction System

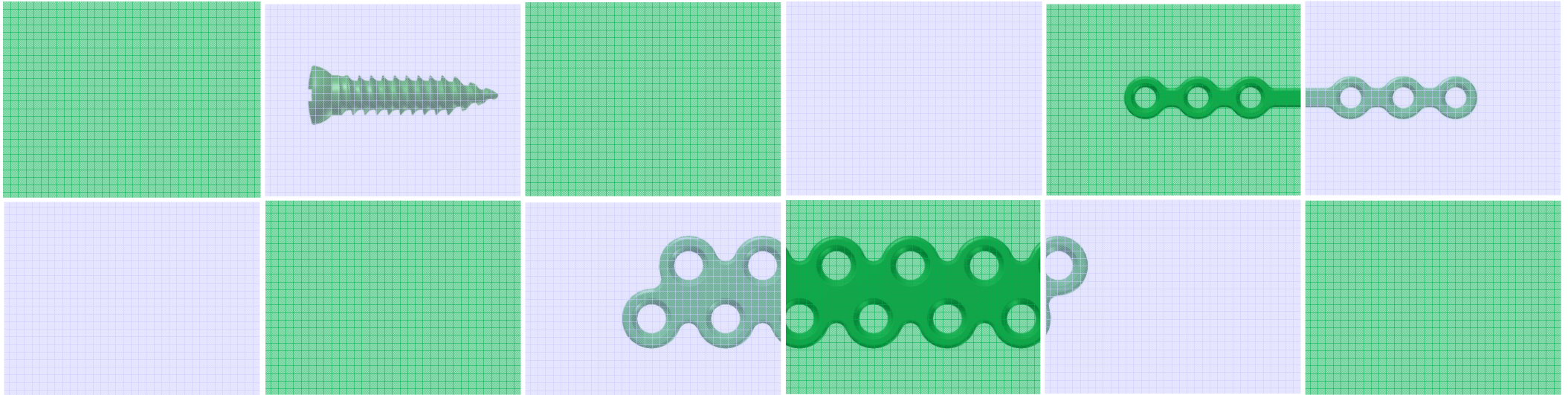

2.0

Thickness 0.8 - 1.0 mm

Maxillofacial



L - Plate 2.0

Titanium	Holes	L / R
MOI 22022005	5	Left
MOI 22055005	5	Right

Thickness: 0.8 mm

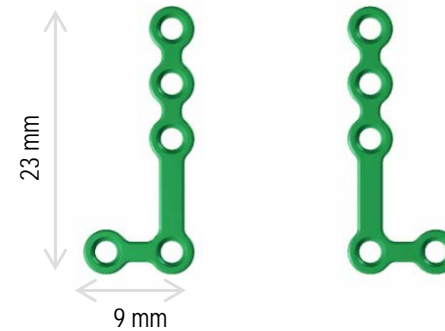

Mandible Plate 2.0, with centre space

Titanium	Holes	Length
MOI 22023004	4	26 mm
MOI 22023006	6	38 mm

Thickness: 0.8 mm Width: 5.0 mm



Mandible Plate 2.0

Titanium	Holes	Length
MOI 22024004	4	23 mm
MOI 22024006	6	35 mm
MOI 22024012	12	70 mm
MOI 22024020	20	118 mm

Thickness: 0.8 mm Width: 5.0 mm

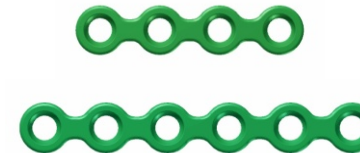

Mandible Plate 2.0, twisted

Titanium	Holes	L / R
MOI 22025004	4	Left
MOI 22026004	4	Right

Thickness: 0.8 mm Width: 5.0 mm Length: 26 mm



Orbital Plate 2.0, curved

Titanium	Holes	Curve Length
MOI 22027004	4	35 mm
MOI 22027005	5	35 mm
MOI 22027007	7	47 mm

Thickness: 0.8 mm Width: 5.0 mm



Double Y - Plate 2.0

Titanium	Holes
MOI 22028006	6

Thickness: 0.8 mm

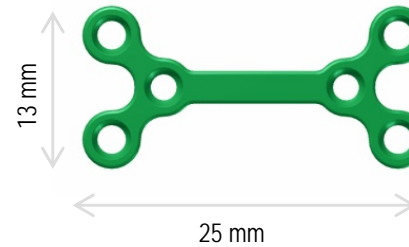

Frame Plate 2.0, square

Titanium	Holes
MOI 22029006	6

Thickness: 0.8 mm

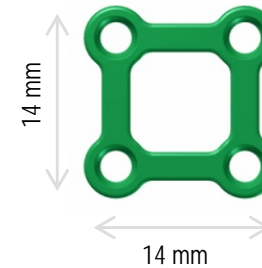

Strut Plate 2.0

Titanium	Holes
MOI 22030024	2 X 4

Thickness: 1.0 mm

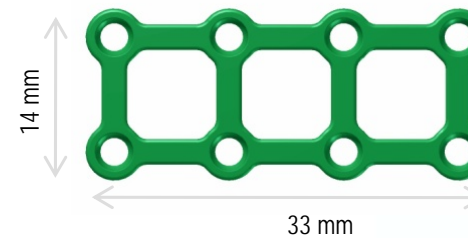

Mandible Strut Plate 2.0, curved

Titanium	Holes	Curve Length
MOI 22031008	8	38 mm

Thickness: 1.0 mm Width: 12.0 mm



Double Wide Plate 2.0

Titanium	Holes	Length
MOI 22032009	9	29 mm
MOI 22032012	12	39 mm

Thickness: 1.0 mm Width: 9.0 mm



Cortex Screw 2.0 mm, cruciform, self - tapping

TAN	Length (mm)
MOI 32033004	4
MOI 32033005	5
MOI 32033006	6
MOI 32033007	7
MOI 32033008	8
MOI 32033010	10
MOI 32033012	12
MOI 32033014	14
MOI 32033016	16
MOI 32033018	18



Cortex Screw 2.0 mm, cruciform, self - drilling

TAN	Length (mm)
MOI 32034004	4
MOI 32034005	5
MOI 32034006	6
MOI 32034007	7
MOI 32034008	8





Cranio-maxillofacial Repair and Reconstruction System

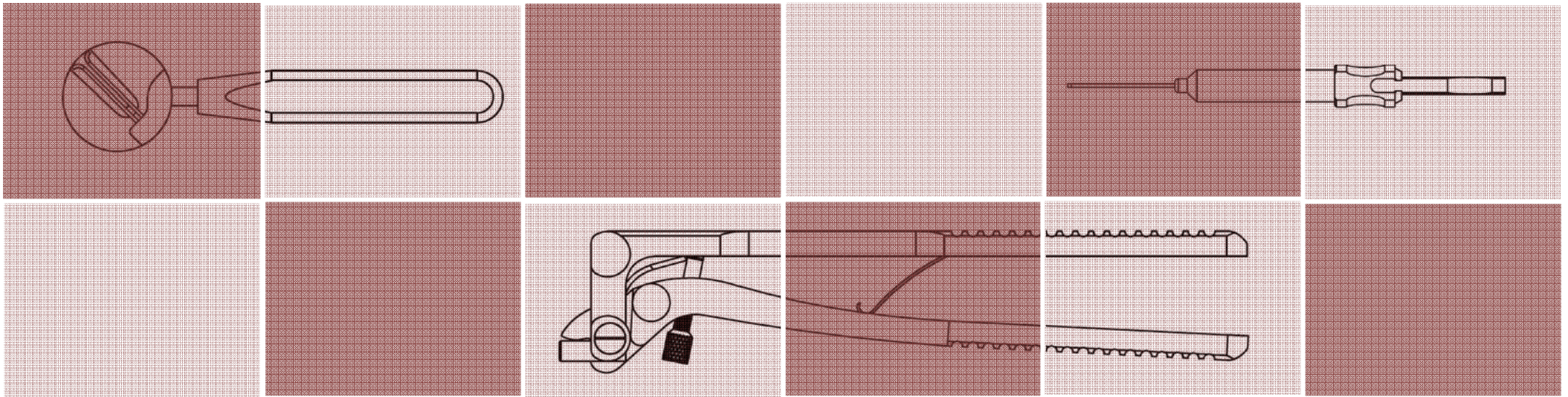

CMF Instrument Sets

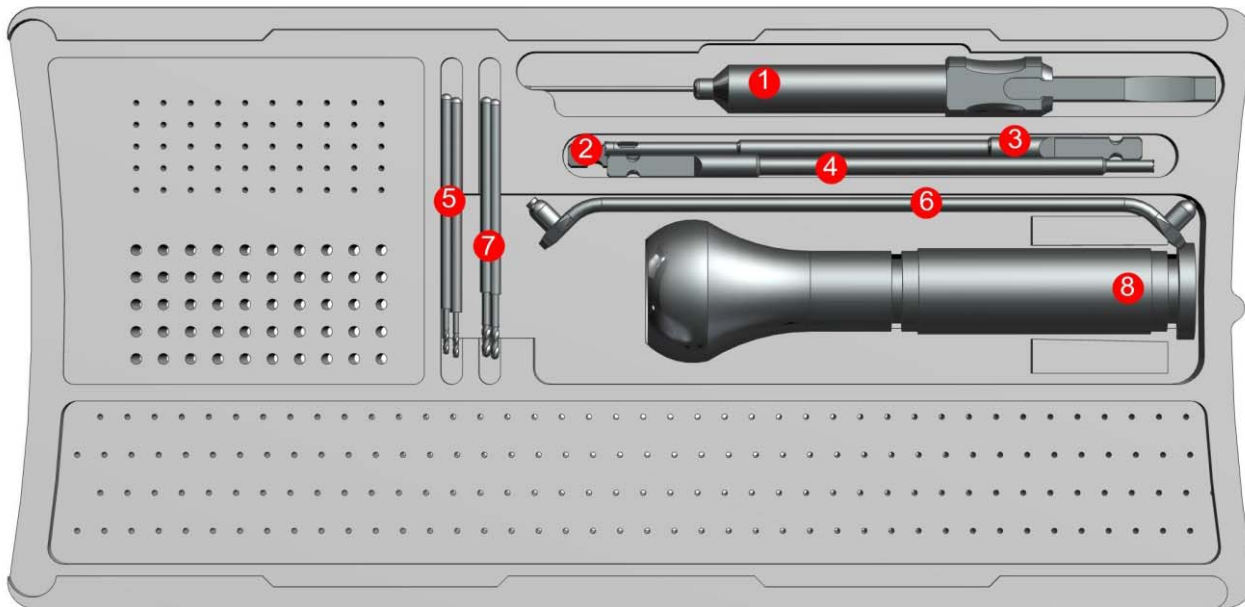

Compact CMF Instrument Set

REF CODE	DESCRIPTION	UNITS
1	MOI102000 Depth Gauge	1
2	MOI1102001 Screwdriver Shaft, cruciform	1
3	MOI1102002 Screw Extractor Ø1.5	1
4	MOI1102003 Screw Extractor Ø2.0	1
5	MOI1102004 Drill Bit Ø1.1 mm	2
6	MOI1102005 Drill Guide Ø1.1 / Ø1.6	1
7	MOI1102006 Drill Bit Ø1.6 mm	2
8	MOI1102007 Handle, with Mini Quick Coupling	1

Compact CMF Instrument Set, for Reconstruction

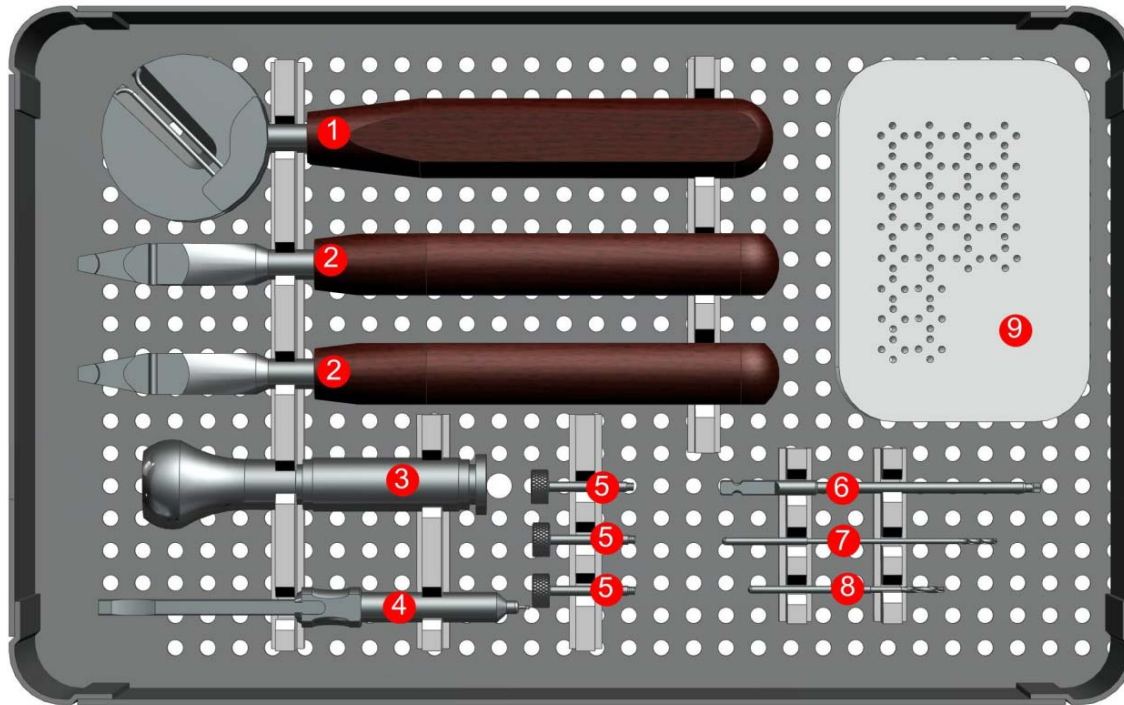

REF CODE	DESCRIPTION	UNITS
1	MOI1101000 Plate Cutter	2
2	MOI1101001 Bending Iron	2
3	MOI1101002 Handle, with Mini Quick Coupling	1
4	MOI1101003 Depth Gauge	1
5	MOI1101004 Drill Sleeve, with thread	3
6	MOI1101005 Screwdriver Shaft, cruciform	1
7	MOI1101006 Drill Bit Ø1.7 mm	2
8	MOI1101007 Drill Bit Ø1.9 mm	2
9	MOI1101008 Screw Container	1

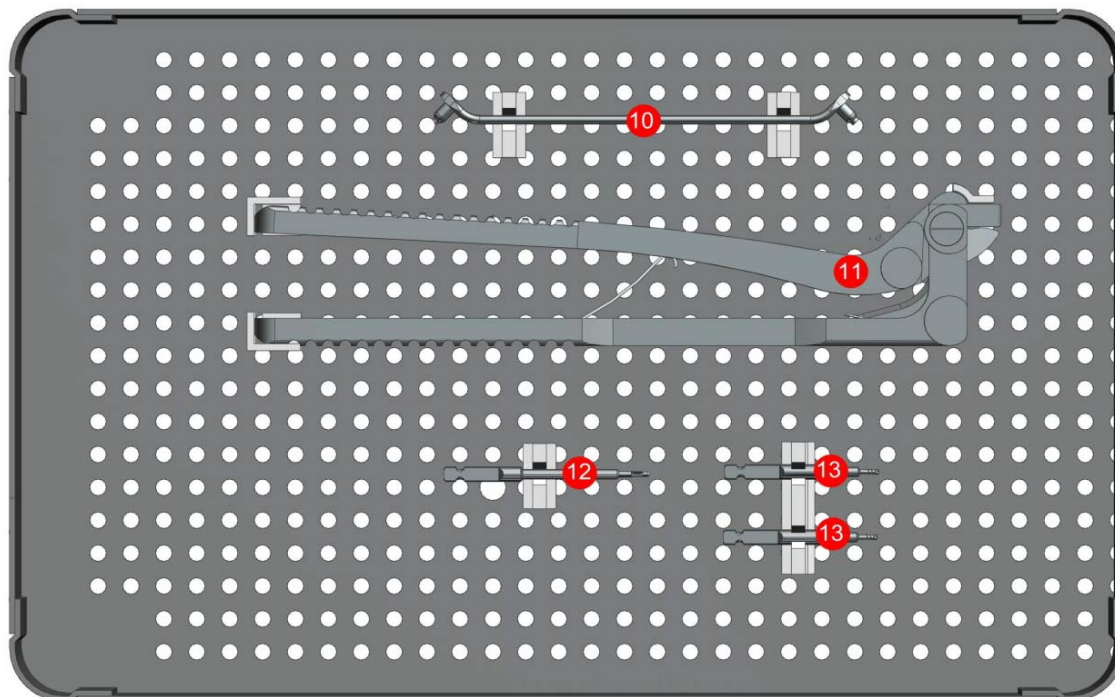

REF CODE	DESCRIPTION	UNITS
10	MOI1101009 Drill Guide Ø1.6 / Ø1.9	1
11	MOI1101010 Combination Bending Pliers	1
12	MOI1101011 Drill Bit Ø2.0 mm	1
13	MOI1101012 Tap	2



TRAUMA

USA OFFICE

4000 Island Blvd, Suite 2704
Aventura, Florida 33160

PUERTO RICO OFFICE

1660 Santa Ana Street
Esq. Fidalgo Diaz,
San Juan, Puerto Rico 00909

E-mail: info@madisonorthoinc.com
Website: www.madisonorthoinc.com

