

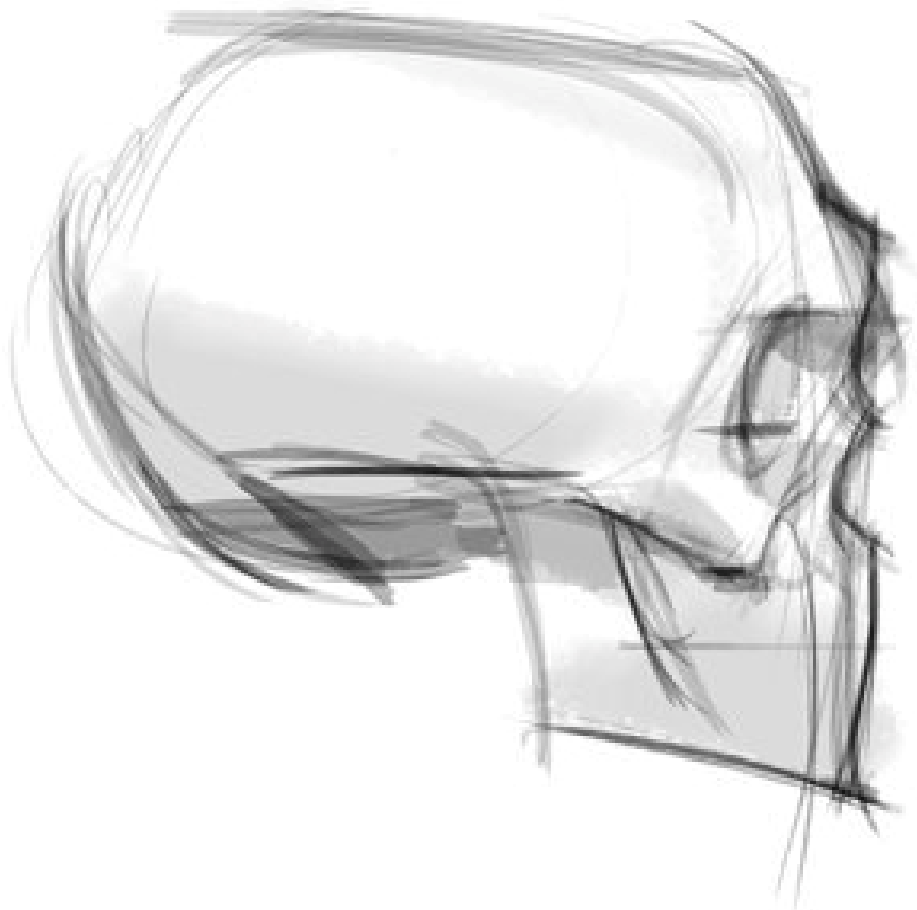

Cranio-maxillofacial Repair and Reconstruction System



Catalogue | *CMF*



Cranio-maxillofacial Repair and Reconstruction System

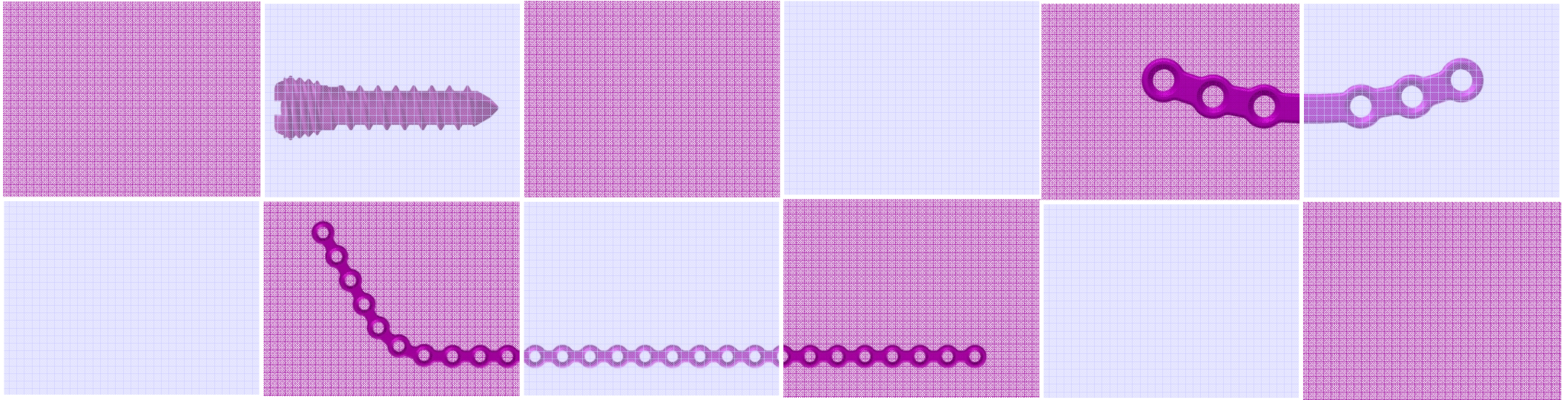

2.0

LOCK

Thickness 2.0 - 2.5 mm

Mandible



LOCK Mandible Plate 2.0, straight

Titanium	Holes	Length
MOI 22041006	6	35 mm
MOI 22041012	12	70 mm
MOI 22041020	20	116 mm

Thickness: 2.0 mm Width: 5.5 mm

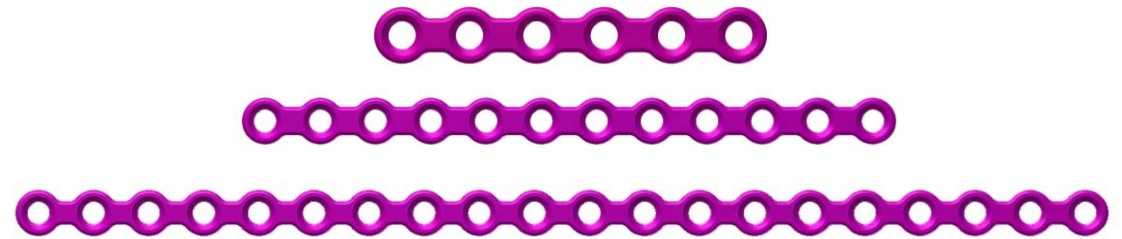

LOCK Mandible Plate 2.0, angled

Titanium	Holes	L / R
MOI 22042621	6 + 21	Left
MOI 22043621	6 + 21	Right

Thickness: 2.5 mm Width: 5.5 mm Curve Length: 152 mm

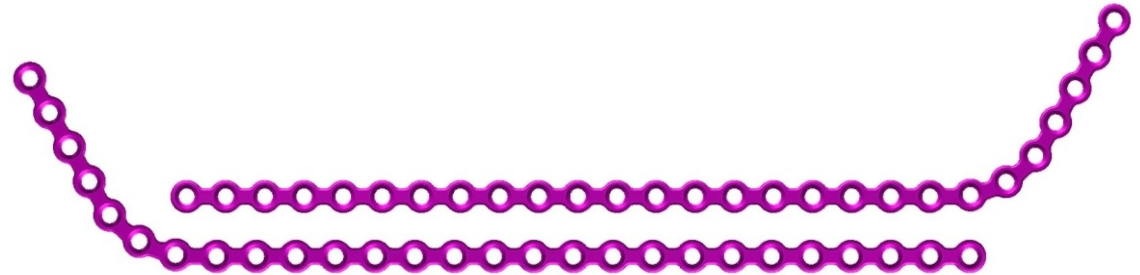

LOCK Mandible Plate 2.0, double angled

Titanium	Holes	Curve Length
MOI 22044420	4 + 20 + 4	164 mm
MOI 22044522	5 + 22 + 5	202 mm
MOI 22044624	6 + 24 + 6	218 mm

Thickness: 2.5 mm Width: 5.5 mm

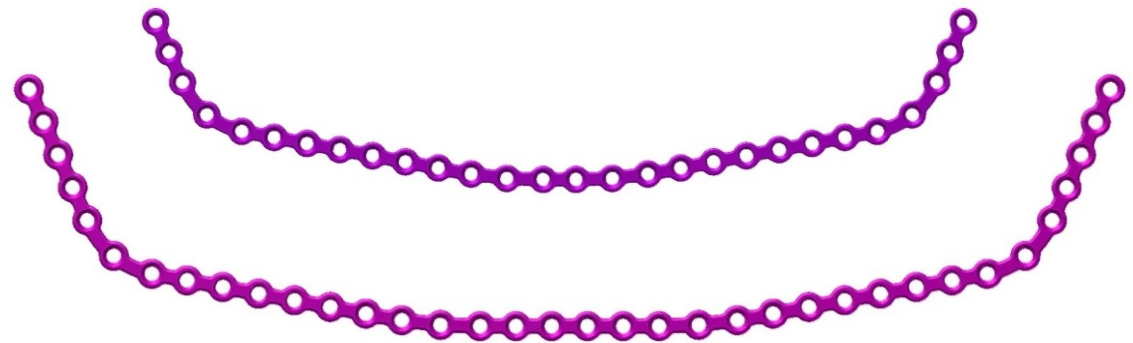

LOCK Mandible Plate 2.0, crescent - shaped

Titanium	Holes	Curve Length
MOI 22045022	2 + 2	35 mm
MOI 22045033	3 + 3	46 mm

Thickness: 2.0 mm Width: 5.5 mm



LOCK Mandible Plate 2.0, arc - shaped

Titanium	Holes	Curve Length
MOI 22046033	3 + 3	60 mm
MOI 22046044	4 + 4	72 mm

Thickness: 2.0 mm Width: 5.5 mm



LOCK Screw 2.0 mm, cruciform, self - tapping

TAN	Length (mm)
MOI 32047005	5
MOI 32047006	6
MOI 32047007	7
MOI 32047008	8
MOI 32047010	10
MOI 32047012	12
MOI 32047014	14
MOI 32047016	16
MOI 32047018	18





Cranio-maxillofacial Repair and Reconstruction System

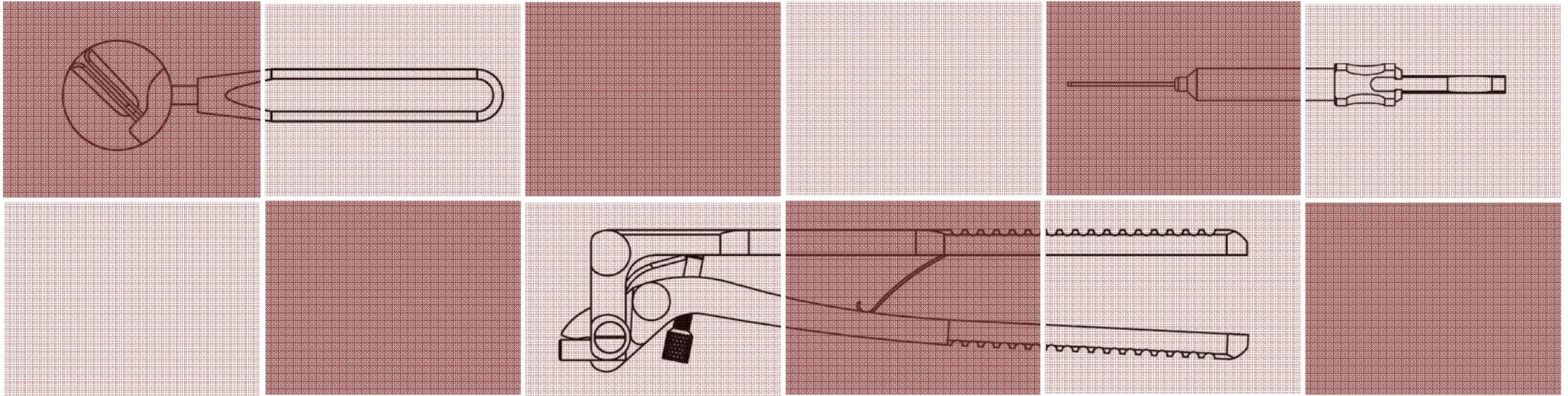

CMF Instrument Sets

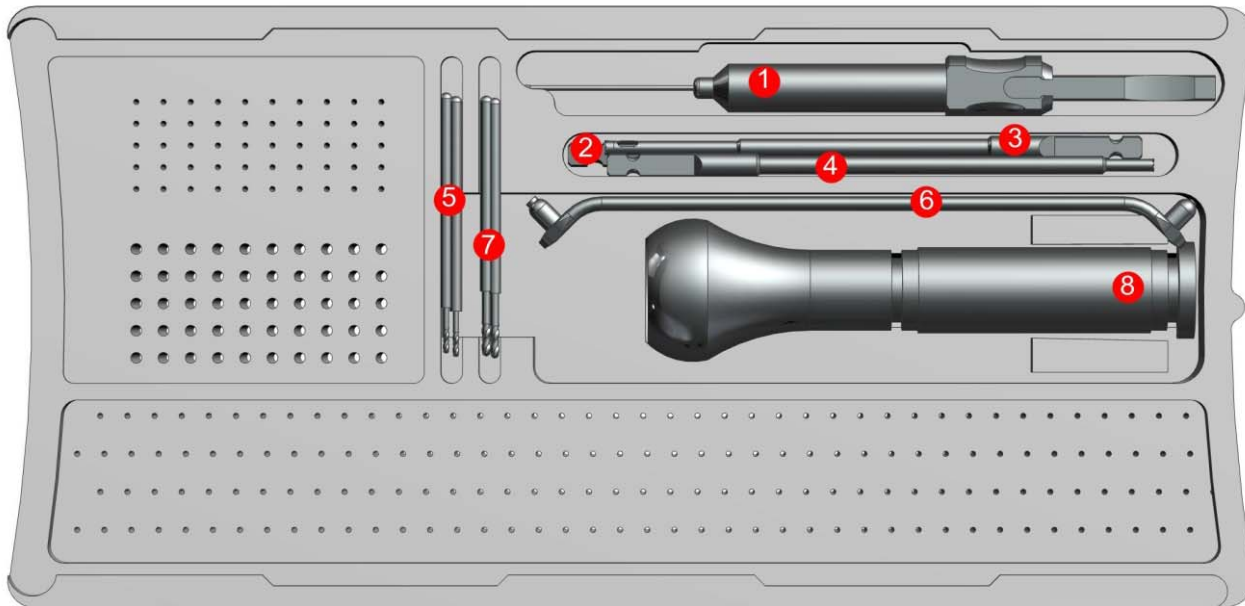

Compact CMF Instrument Set

REF CODE	DESCRIPTION	UNITS
1	MOI102000 Depth Gauge	1
2	MOI1102001 Screwdriver Shaft, cruciform	1
3	MOI1102002 Screw Extractor Ø1.5	1
4	MOI1102003 Screw Extractor Ø2.0	1
5	MOI1102004 Drill Bit Ø1.1 mm	2
6	MOI1102005 Drill Guide Ø1.1 / Ø1.6	1
7	MOI1102006 Drill Bit Ø1.6 mm	2
8	MOI1102007 Handle, with Mini Quick Coupling	1

Compact CMF Instrument Set, for Reconstruction

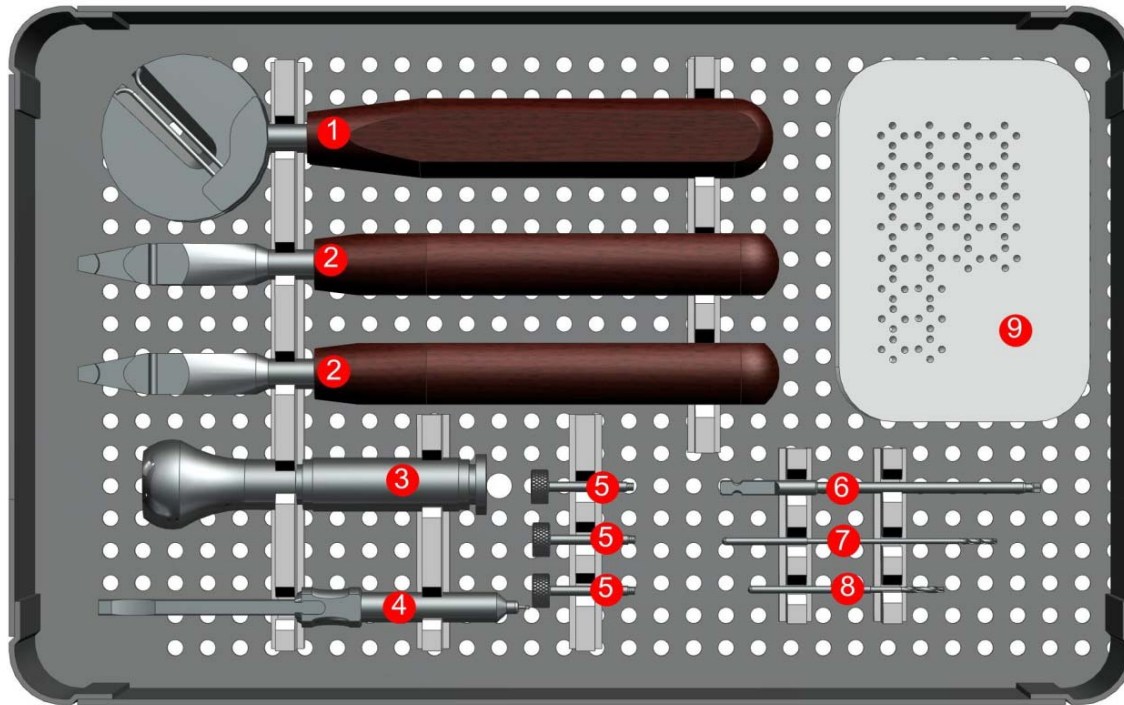

REF CODE	DESCRIPTION	UNITS
1	MOI1101000 Plate Cutter	2
2	MOI1101001 Bending Iron	2
3	MOI1101002 Handle, with Mini Quick Coupling	1
4	MOI1101003 Depth Gauge	1
5	MOI1101004 Drill Sleeve, with thread	3
6	MOI1101005 Screwdriver Shaft, cruciform	1
7	MOI1101006 Drill Bit Ø1.7 mm	2
8	MOI1101007 Drill Bit Ø1.9 mm	2
9	MOI1101008 Screw Container	1

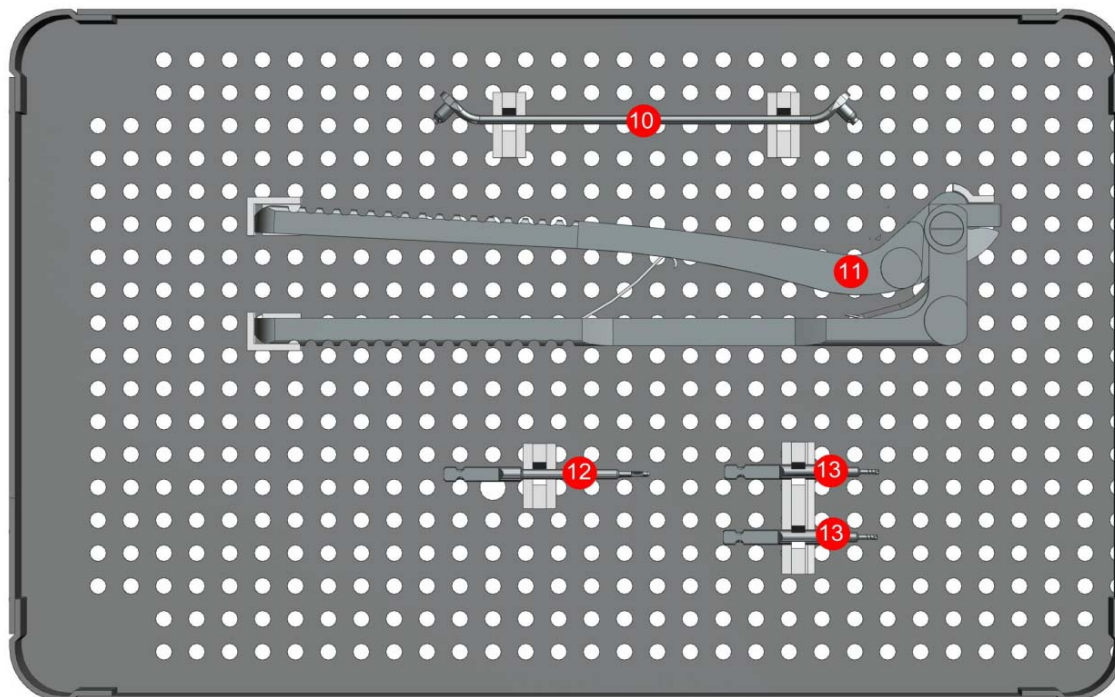

REF CODE	DESCRIPTION	UNITS
10	MOI1101009 Drill Guide Ø1.6 / Ø1.9	1
11	MOI1101010 Combination Bending Pliers	1
12	MOI1101011 Drill Bit Ø2.0 mm	1
13	MOI1101012 Tap	2



TRAUMA

USA OFFICE

4000 Island Blvd, Suite 2704
Aventura, Florida 33160

PUERTO RICO OFFICE

1660 Santa Ana Street
Esq. Fidalgo Diaz,
San Juan, Puerto Rico 00909

E-mail: info@madisonorthoinc.com
Website: www.madisonorthoinc.com

